

BALANCED HEAD FAIRLEAD DECK MOUNTED

MD-618

STANDARD FEATURES

- Designed for Breaking Strength of 1-1/2" (38 mm) EIPS Wire Rope, 228,000 LBS, with 90° Wrap on the Sheave and $\pm 90^\circ$ Rotation of Swivelhead
- Cast Steel Sheave with Hardened Rope Groove for Longer Life
- Sealed Grease Lubricated Tapered Roller Bearings in Sheave and Swivelhead
- Weld Down Mounting Base
- Removable Guide Roller
- Epoxy Primer Coating

OPTIONAL FEATURES

- Customized Design to Suit Your Application
- Tail Sheaves / Tail Rollers
- Stainless Steel or Nylon Sheaves
- Bolt Down Mounting Base
- Load Monitoring System
- Three Coat Marine Paint System
- Third Party Certification

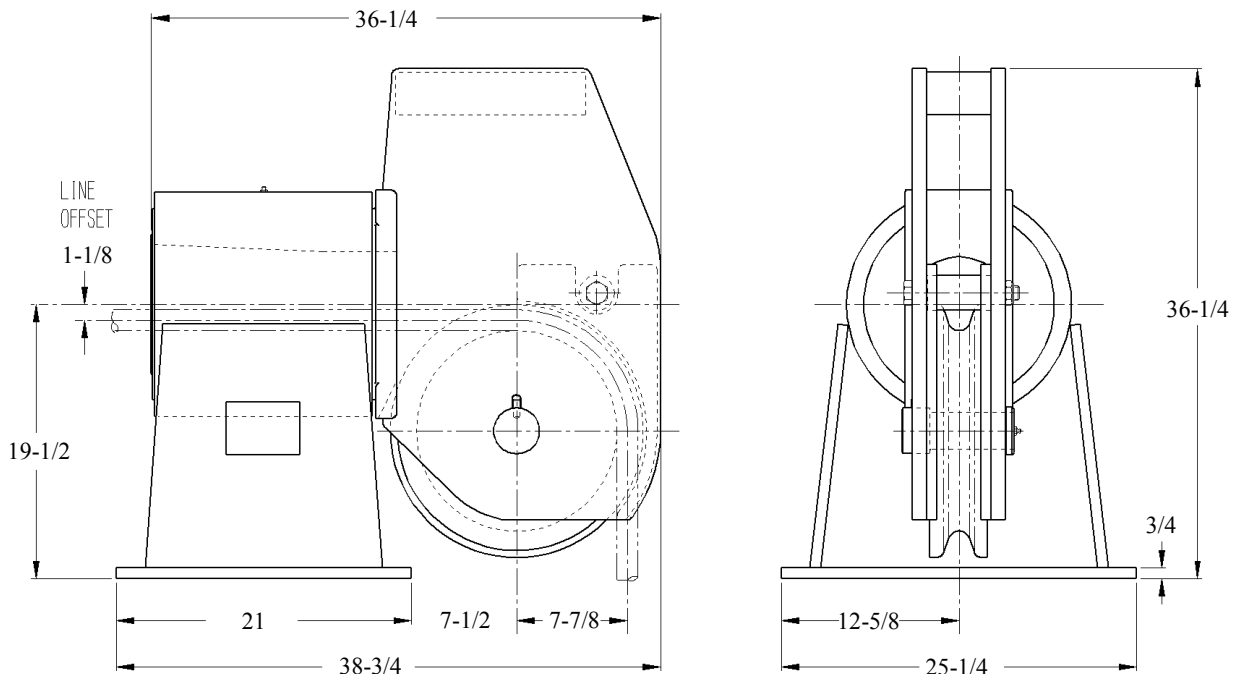
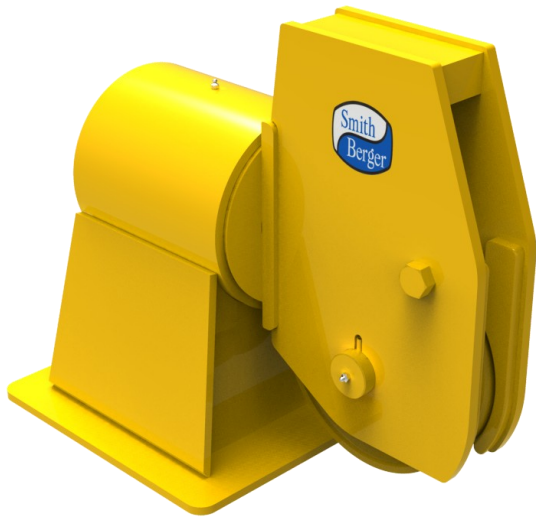

* DIMENSIONS SUBJECT TO CHANGE WITHOUT NOTICE*

WEIGHT: 1,420 LBS

Smith Berger Marine, Inc. - Mooring & Towing Solutions

7915 10th Ave. S., Seattle, WA 98108 USA

Tel. 206.764.4650 - Toll Free 888.726.1688 - Fax 206.764.4653

E-mail: sales@smithberger.com - Web: www.smithberger.com