

TOW PIN / STERN ROLLER

# MODEL 9T314-1HD

## STANDARD FEATURES

- Designed for the Breaking Strength of  $\text{Ø}1\text{-}1/2$ " Wire Rope ( 198,400 Lbs) with 45° of Wrap on Pin and 45° Upward Lead from Hook.
- Heat Treated Vertical Rollers with Grease Lubricated Bronze Bearings
- Furnished with Marine Grade Hydraulic Cylinders w/ Stainless Steel Rods and Synthetic Bushings
- Hydraulic Power Unit and Remote Control Panel
- Marine Paint System
- Every unit is functionally tested at the factory.

## OPTIONAL FEATURES

- Mounting Frames Customized to Suit any Vessel
- Local Controls
- Load Tests
- Third Party Certification

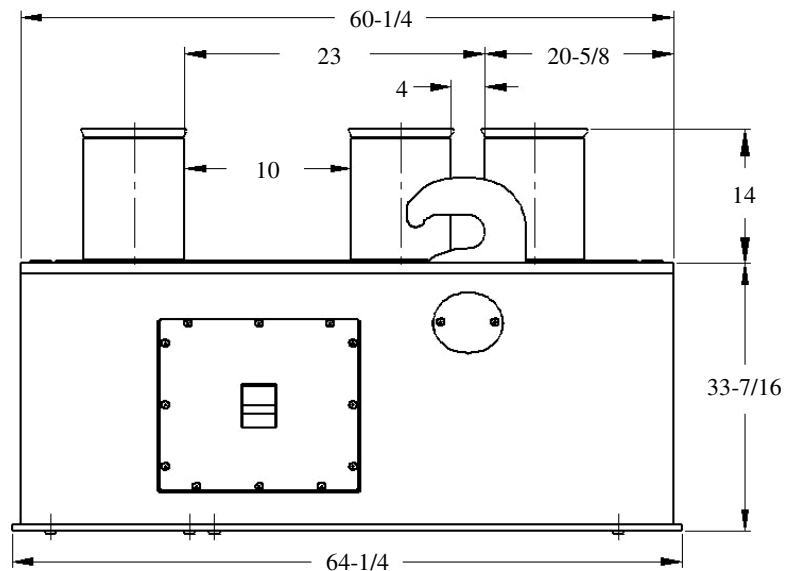
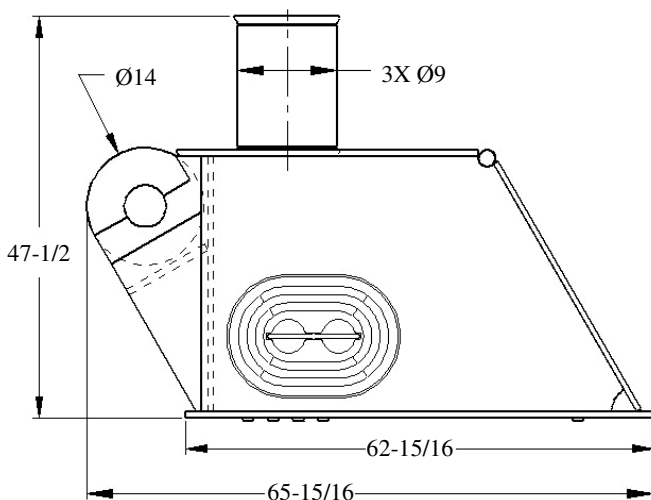

WEIGHT: 5070 LBS

\* DIMENSIONS SUBJECT TO CHANGE WITHOUT NOTICE\*

**Smith Berger Marine, Inc. - Mooring & Towing Solutions**

7915 10<sup>th</sup> Ave. S., Seattle, WA 98108 USA

Tel. 206.764.4650 - Toll Free 888.726.1688 - Fax 206.764.4653

E-mail: [sales@smithberger.com](mailto:sales@smithberger.com) - Web: [www.smithberger.com](http://www.smithberger.com)