

FOUR ROLLER
FAIRLEAD

MODEL FR4-10

STANDARD FEATURES

- Designed with a S.W.L. of 100MT (220,460 Lbs or 980.7 kN) per O.C.I.M.F. Rev.3 Guidelines.
- Hardened Rollers for Longer Life
- Grease Lubricated Bronze Bearings
- Epoxy Primer Coating

OPTIONAL FEATURES

- Customized Design to Suit Your Application
- Seawater Lubricated Bearings for Underwater Use
- Bolt Down Mounting Base
- Stainless Steel Rollers
- Load Monitoring System
- Three Coat Marine Paint System
- Third Party Certification

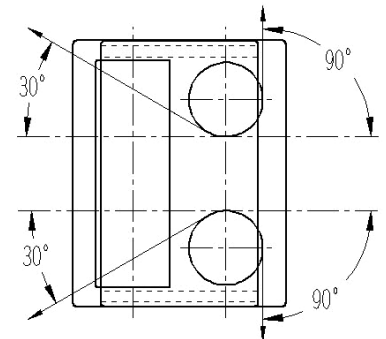
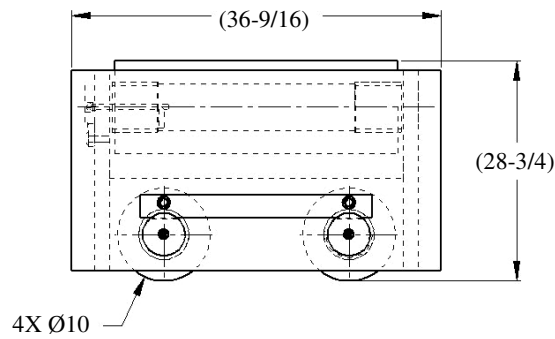

PLAN LOADING LIMITS

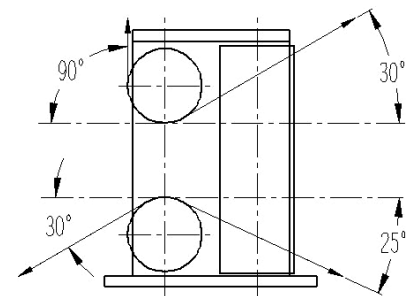
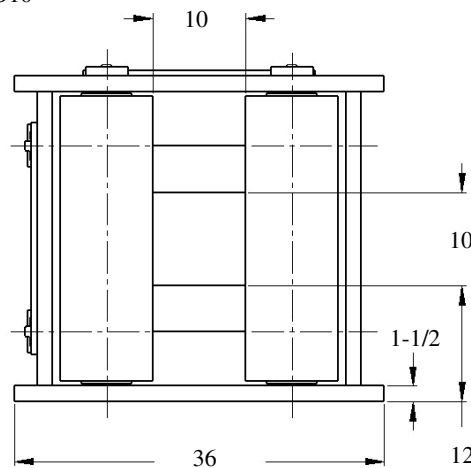
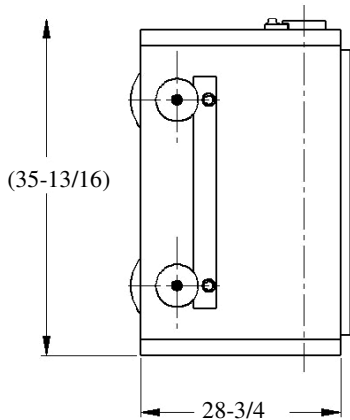

ELEVATION LOADING LIMITS

* DIMENSIONS SUBJECT TO CHANGE WITHOUT NOTICE*

WEIGHT: 3350 LBS

Smith Berger Marine, Inc. - Mooring & Towing Solutions

7915 10th Ave. S., Seattle, WA 98108 USA

Tel. 206.764.4650 - Toll Free 888.726.1688 - Fax 206.764.4653

E-mail: sales@smithberger.com - Web: www.smithberger.com